



# **XTR II™ Riflescopes User Guide**

*This user guide includes information for the entire XTR II riflescope line. Please review thoroughly, and pay close attention to the details pertaining to your specific riflescope model.*

Congratulations on choosing the XTR II™ riflescope from Burris®. The XTR II has improved upon the original Xtreme Tactical Riflescope design, now offering these premium features:

- **Five Times Zoom System.** Highly versatile five times zoom system allows for a larger field of view at close ranges and better target acquisition at long ranges.
- **Zero Click Stop™ Adjustment Knobs.** Allows shooter to quickly and easily revert back to the original sight-in setting without counting clicks or referencing marks.
- **Tactical Reticles.** The XTR II line-up gives you a choice in tactical appropriate reticles, including the XTR II Ballistic 5.56 Rear Focal and Dual Focal Plane reticles; the Ballistic CQ Mil reticle; the G2B Mil-Dot reticle; the SCR and SCR MOA reticles; and the F-Class MOA reticle. All provide accurate trajectory and windage compensation and are ideal for tactical applications. Illuminated models are compatible with night vision gear.
- **Advanced Windage & Elevation Adjustment.** Accurate and repeatable reticle adjustments match the measurement system of the reticle, making windage and elevation adjustments fast and easy.
- **Side Focus.** Ergonomic side focus allows for easy-to-reach parallax adjustment.
- **High Performance Glass.** Provides excellent brightness and clarity with lasting durability – exactly what you expect from Burris.
- **Index-Matched, Hi-Lume® Multi-Coated Lenses.** Enhanced low-light performance and glare elimination, making more shots possible and increasing your success rate.
- **Rugged, Combat-Ready Performance.** Throw everything you've got at these riflescopes – they can take it and still deliver.



WATERPROOF



SHOCKPROOF



NITROGEN-FILLED



FOGPROOF





## How to use the XTR II Riflescope

### **Eyepiece Focusing**

The eyepiece can be focused so that the reticle appears sharp and black to any individual's eye. Adjusting the focus is quick and easy to do, just follow this procedure:

1. Point the scope at the sky or a plain wall and take a quick glance through the scope. If the reticle appears sharp and black, no further adjustment is necessary.
2. If the reticle does not appear sharp and black, take quick glances through the scope while rotating the eyepiece focus ring until the reticle pattern is sharp and black.

NOTE: Do not look through the eyepiece as you turn the focus ring. Your eyes will adjust to the out-of-focus condition.

### **Parallax/Focus Adjustment**

*– Parallax adjustment is not available on 1-5x and 1.5-8x models –*

Parallax is the apparent movement of the reticle in relation to the target when the eye is not directly in line behind the center of the scope. Images from different distances focus in front of or behind the scope's reticle. Parallax is more noticeable with higher magnification scopes.

To use the parallax/focus adjustment, rotate the knob on the left side of the adjustment turret until the numeral corresponding to the known target distance lines up with the reference mark. If the distance is unknown, rotate the adjustment knob until the target image is sharply focused.

When the scope is set parallax-free for the distance you are viewing, you should be able to move your eye side-to-side or up and down without seeing the reticle move appreciably in relation to the target.



## Windage/Elevation Adjustment for Multi-Turn Knobs – Applies to 2-10x; 3-15x; 4-10x; 5-25x; and 8-40x models –

The windage and elevation knobs are designed for precise adjustment. The click value for each knob is indicated on the dial.

Models featuring the XT-100 elevation knob offer 10 Mils or 25 MOA of adjustment per rotation with multiple revolutions of adjustment. XT-80 elevation knobs offer 8 mils or 20 MOA per rotation with multiple revolutions of adjustment; 8-40x models have 10 MOA per rotation.

This riflescope is shipped from the factory with the optical center set 20 MOA below center. Without tapered bases, the initial sight-in or bore sighting will likely produce a considerably high initial point of impact. Because of the Zero Click Stop™ feature, as shipped from the factory the scope has no immediate capability for downward point-of-impact adjustment.

**Use the following procedure whenever you need downward point of impact adjustment:**

- 1) Turn the elevation adjustment knob clockwise to “0”.



- 2) Use the 2mm hex wrench supplied with the scope to loosen the set screws on the elevation adjustment knob located just under the top of the knob. The knob should spin freely.



- 3) Pull up slightly on the adjustment knob to the second white hash mark on the turret. Turn the knob clockwise slightly more (2-5 clicks more) than the number of mils needed to achieve zero.



- 4) Retighten the set screws. Adjust the elevation down the required amount.

- 5) Once the elevation adjustment is complete, once again loosen the two set screws and reset the knob to "0". With the screws loose, push down firmly on the knob until it is fully seated on the turret base and turn the knob clockwise until it stops against the Zero Click Stop. Then retighten the set screws.

NOTE: Windage adjustments are made with a multi-direction adjustment knob. Zero is set with an indexing mark to allow for left and right adjustments. Failure to zero at the index mark may result in limited windage adjustment.



**Proper Windage Zero**

### **Windage/Elevation Adjustment for Single-Turn Knobs**

– *Applies to 1-5x and 1.5-8x models* –

The windage and elevation knobs are designed for precise adjustment. The click value for each knob is indicated on the dial.

The elevation knob at the top of the tube provides 9.3 mRAD of adjustment in one full turn and features a Zero Click Stop™. The windage knob, located on the right side of the tube, provides up to 4.6 mRAD of adjustment in both directions.

Both knobs can be reset to "0" once the scope is sighted-in. To reset the knobs to "0," use the hex wrench supplied with the scope to loosen the set screws located at the top of the adjustment knobs.



The knob should spin freely. Rotate the knob until the "0" lines up with the hash mark indicator, and then retighten the set screws. The knob is not intended to come up or off, but if the set screws are loosened too far, the knob can be removed. The scope is still fully sealed if this does accidentally occur.



## Illuminated Reticle Adjustment

Models with an illuminated reticle make it easier to see the reticle in low light conditions. The intensity of the illumination is controlled by the rotary illumination switch located on the left side of the adjustment turret. The switch has 11 intensity levels and a "battery saver" position in between each level that turns off the illumination. The illumination levels rise in brightness intensity from 1–11, with the lowest levels capable of working with night vision equipment, the middle levels ideal for low light conditions, and the highest levels suitable for daytime usage (other than 8-40x, see page 17 for details). The "Off" positions at the minimum and maximum ranges turn the circuit off completely and should be used when the scope is not in use. Each level also has a detent to prevent unintended changes during use.

**Time-Out Function:** XTR II Riflescopes arrive from the factory with an automatic Time-Out Function. After 3 hours the illumination will automatically shut off to conserve battery life.

This Time-Out Function will operate even when the scope is set on a "battery saver" position. When this occurs, you must turn the illumination to one of the "Off" positions at the minimum and maximum ranges to reset the Time-Out Function and reactivate the illumination. This function can be disabled, if desired. Contact Customer Service for details.

The reticle is powered by a 3-volt lithium cell battery #CR2032. To install a new battery, simply unscrew the battery cap on the rotary switch and install the new battery flat side (+) up. It is advisable to remove the battery for long-term storage (over a month).



## Mounting the Scope

Most XTR II riflescopes require 34mm rings; the 1-5x requires 30mm rings. We recommend using high-quality rings and bases, like the Burris Xtreme Tactical Rings and Xtreme Tactical Bases. Quality components ensure that your scope will remain safely and securely mounted, and will provide the maximum accuracy. Use care when mounting your scope as damage caused by improper mounting is not covered by the Burris Forever Warranty.

## Care & Maintenance

The XTR II riflescope is fully waterproof and fogproof. To protect the objective and ocular lenses, it comes equipped with flip-up scope caps. In the event that the lenses are subjected to dust, dirt, or mud, follow these steps to clean and protect the lens surface. Failure to remove grit before final cleaning is sure to damage lens coatings.

Coarse dirt/debris must be removed from the lens surface. The most convenient way to clean a lens surface is to use a Lens Pen. Position the scope so particles will fall away from the lens, and then use the Lens Pen or soft brush to gently whisk away the debris while blowing on the lens to dislodge the particles. For heavy dirt, like dried mud, use a spray of clean water or lens cleaning fluid to remove the dirt.

Your Burris riflescope will provide reliable performance given reasonable care and treatment. All moving assemblies are permanently lubricated. Only occasional cleaning of the outside of the scope and the exterior lenses is required. Never disassemble your scope. Disassembly by anyone other than our factory will void the warranty. If you have any other problems with your riflescope, return it to the Burris factory for repair.

## XTR II Rifle Scope Reticles

XTR II riflescopes give you a variety of reticle choices, and feature front, rear, or dual focal plane systems.

### Front Focal Plane (FFP)

Front Focal Plane systems (also referred to as First Focal Plane systems) place the reticle in front of the erector assembly or zoom mechanism. This allows the reticle to change size as magnification is adjusted. In FFP systems, when magnification is increased, the reticle size grows; as magnification is lowered, the reticle size shrinks. Because the reticle is changing with magnification, the measurements of the reticle are always correct and are proportional to whatever power setting you may be on. This can be very useful in tactical situations when reticles are used to determine size and distance of a target, and when using the reticle for trajectory compensation at multiple magnification settings.

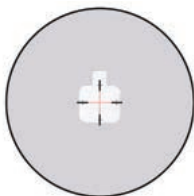

Low Power View

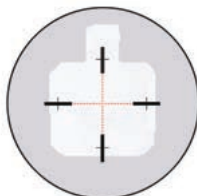

High Power View

### Rear Focal Plane (RFP)

Rear Focal Plane systems (also referred to as Second Focal Plane systems) place the reticle to the rear of the erector assembly or zoom mechanism. This is the most common reticle system and is found in most hunting optics. Because the reticle is behind the zoom mechanism, the size of the reticle is constant and does not change when magnification is adjusted. This will make the reticle appear to consume more of the target on low power; on high power, the reticle will appear to consume less of the target, which is beneficial for long-range, precision shooting.

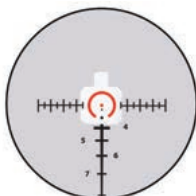

Low Power View

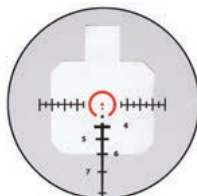

High Power View

Since the reticle size never changes on RFP systems, it is important to understand that the reticle measurements will only be correct on one specific power. For the XTR II 1-5x rifle scope, the measurements are correct at 5x power.



## Dual Focal Plane System

The XTR II Dual Focal Plane system separates an illuminated center aiming point from the Ballistic Drop Compensation (BDC) and Milling portions of the reticle. This places the illuminated aiming point in the RFP and the BDC/Milling reticle in the FFP. This allows the illuminated aiming point to remain a constant size, ensuring the dot is large enough to be effective at low power for close-quarter shooting. The BDC/Milling feature (which is in the FFP) changes size with magnification, meaning the measurements are always correct and proportionate to the magnification. Since the two portions of the reticle are acting independently, the portions will overlap slightly at certain magnifications, but this will not prevent the shooter from using the reticle correctly.

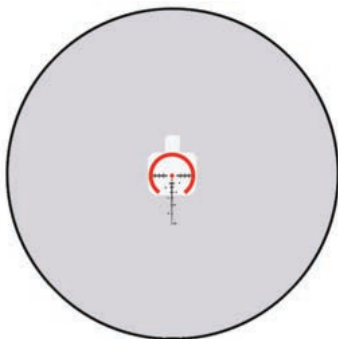

Low Power View

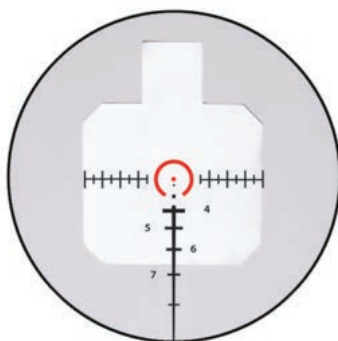

High Power View

The illuminated aiming point, or the RFP portion of the reticle, is only visible when illuminated. The FFP portion of the reticle has no illumination capability.

## XTR II Ballistic 5.56 Gen 3 Illuminated Reticle Rear Focal Plane Reticle

Calibrated to a .223 62gr FMJ at 3025 fps@2000' altitude, .307 BC.

\*Subtensions shown for High Power Magnification.

XTR Ballistic 5.56 Gen 3 Illuminated Rear Focal Plane reticle helps shooters achieve maximum accuracy with 5.56/.223 ammunition. It utilizes milradian measurements and an illuminated "broken circle" with center dot that allows for ultra-fast engagement at short distances. The RFP design keeps the reticle size constant, ensuring it's large enough to be successful when close quarter shooting while still performing well during long-range, precision shooting.

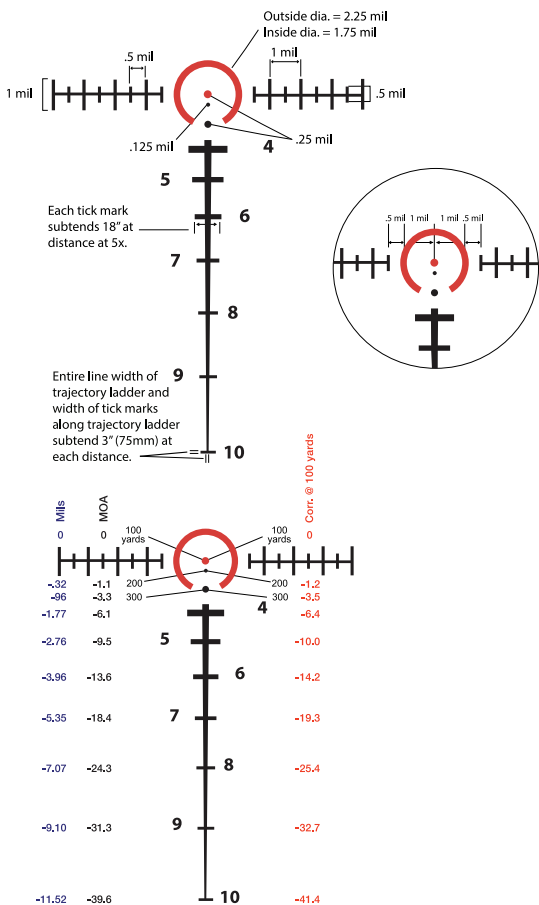

## XTR II Ballistic CQ Mil Illuminated Reticle Rear Focal Plane Reticle

XTR Ballistic CQ Mil Illuminated Rear Focal Plane reticle utilizes milradian measurements and an illuminated "broken circle" with center dot that allows for ultra-fast engagement at short distances. The RFP design keeps the reticle size constant, ensuring it's large enough to be successful when close quarter shooting while still performing well during long-range, precision shooting.

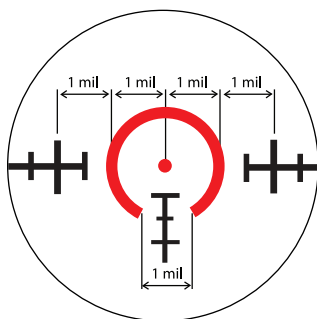
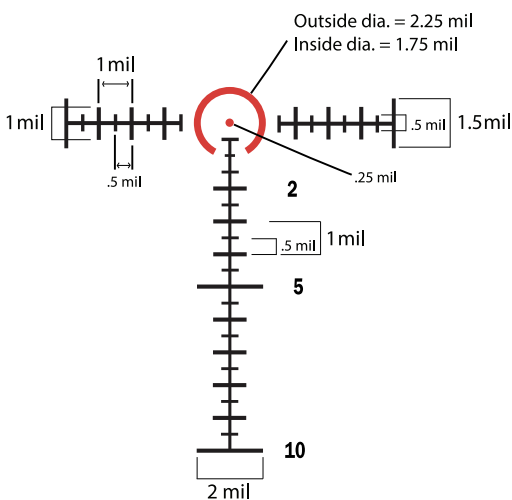

## XTR II Ballistic 5.56 Gen 3 Illuminated Reticle Dual Focal Plane Reticle

Calibrated to a .223 62gr FMJ at 3025 fps@2000' altitude, .307 BC.

XTR Ballistic 5.56 Gen 3 Illuminated Dual Focal Plane reticle helps shooters achieve maximum accuracy with 5.56/.223 ammunition. It utilizes milradian measurements and an illuminated "broken circle" with center dot that allows for ultra-fast engagement at short distances. The DFP design allows the illuminated "broken circle" to remain a constant size, while the reticle changes size with magnification ensuring accurate measurements and trajectory compensation at any power.

### High Power View

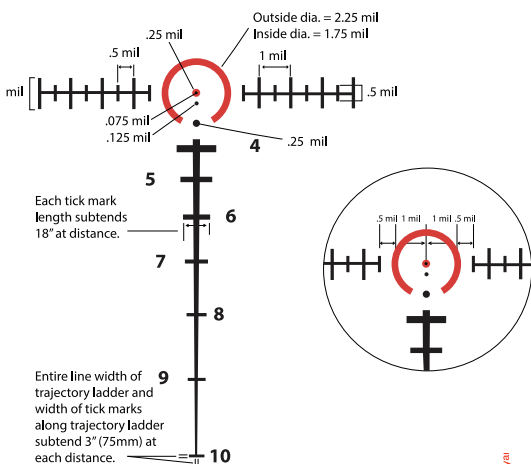

### Low Power View

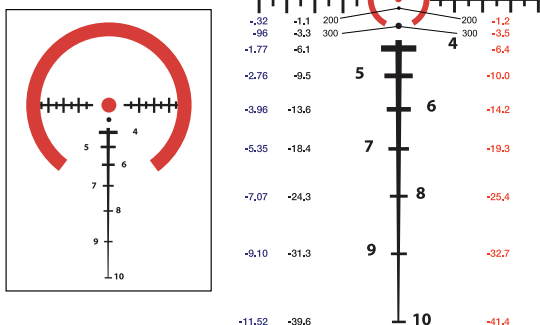

## Tactical Ballistic Calibration Examples

### XTR II Ballistic 5.56 Gen 3

**5.56, 62gr FMJ**  
 .307BC 3025fps  
 Sight Height 2.3"  
 Altitude 2000ft

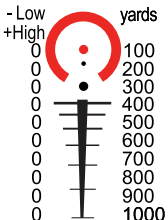

**5.56 55gr FMJ**  
 .243BC 3200fps  
 Sight Height 2.3"  
 Altitude 2000ft

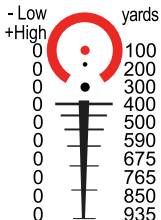

**5.56 50gr V-Max**  
 .242BC 3300fps  
 Sight Height 2.3"  
 Altitude 2000ft

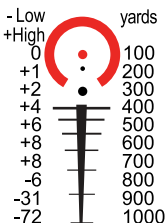

**5.56 68gr HMatch**  
 .355BC 2850fps  
 Sight Height 2.3"  
 Altitude 2000ft

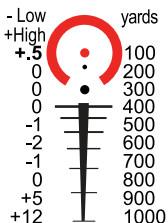

**5.56 77gr SMK**  
 .372BC 2750fps  
 Sight Height 1.8"  
 Altitude 2000ft

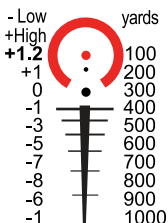

**7.62 150gr FMJ**  
 .425BC 2750fps  
 Sight Height 2.3"  
 Altitude 2000ft

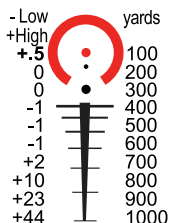

**7.62 168gr SMK**  
 .462BC 2650fps  
 Sight Height 2.3"  
 Altitude 2000ft

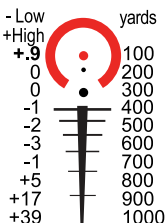

## XTR II Ballistic CQ Mil Illuminated Reticle Dual Focal Plane Reticle

XTR Ballistic CQ Mil Illuminated Dual Focal Plane reticle utilizes milradian measurements and an illuminated "broken circle" with center dot that allows for ultra-fast engagement at short distances. The DFP design allows the illuminated "broken circle" to remain a constant size, while the reticle changes size with magnification ensuring accurate measurements and trajectory compensation at any power.

### High Power View

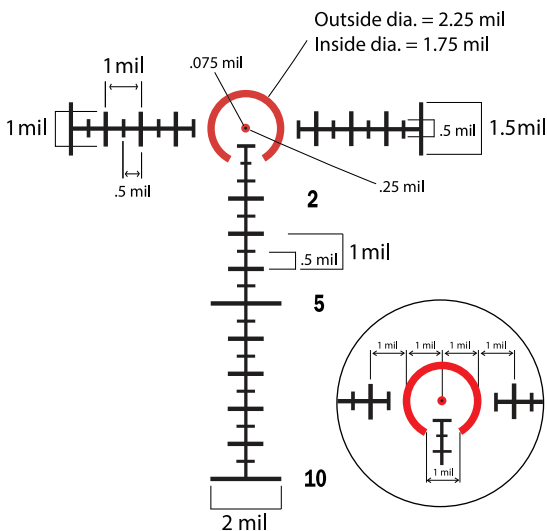

### Low Power View

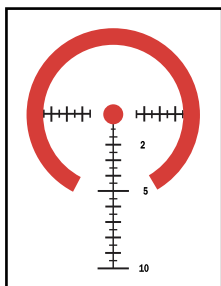

## G2B Mil Dot Reticle Front Focal Plane Reticle

The G2B Mil-Dot Illuminated Focal Plane Reticle is a mil-based reticle with hash marks in between the mil dots for more precise aiming, distance measurement, holdover and hold-off for wind. The center portion of the reticle is illuminated on models with illumination capabilities. FFP design means the reticle size changes with magnification, ensuring that the reticle measurements are always correct and proportional to whatever power setting you may be on. This reticle is excellent in tactical situations when determining size and distance of a target is critical.

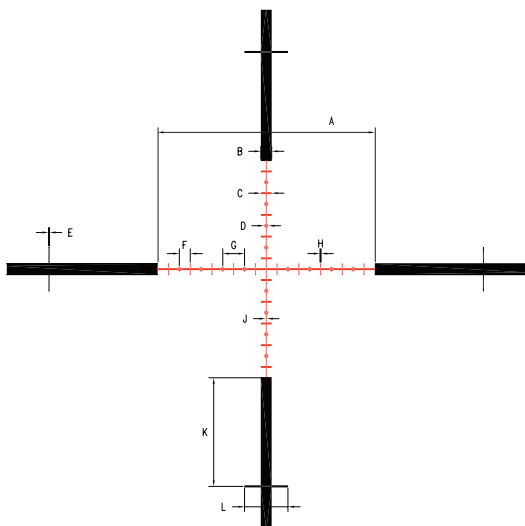

### Reticle Subtensions:

Units	A	B	C	D	E	F	G	H	J	K	L
mRad	10	0.5	0.5	0.2	0.05	0.5	1.0	0.05	0.05	5.0	2.0
in/100 yd.	36	1.8	1.8	0.72	.18	1.8	3.6	.18	.18	18	7.2
cm/100 m	100	5.0	5.0	2.0	0.5	5.0	10	0.5	0.5	50	20

## SCR™ Reticle

- Mil-based, proprietary Burris design.
- Increases precision for long-range competition, without adding clutter or distraction.
- Extended center illuminated area lets the shooter confidently engage targets at long distances in low light and shadows.
- Increases speed and precision for wind hold-off and impact measurement.

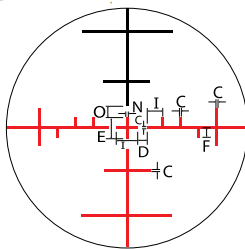
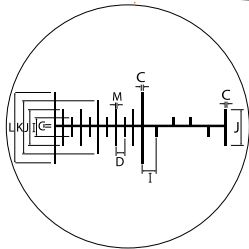
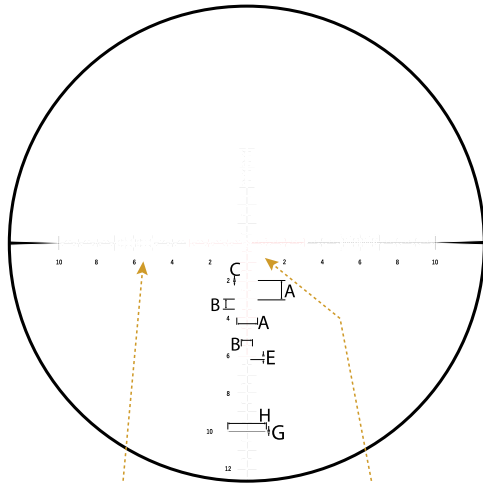

### RETICLE SUBTENSIONS

Unit	A	B	C	D	E	F	G	H	I	J	K	L	M	N	O
<b>4-20x50 and 5-25x50</b>															
Mils	1.00	0.50	0.035	0.10	0.25	0.10	0.08	2.00	0.20	0.40	0.60	0.80	0.02	0.03	0.125
CM	10	5	0.35	1	2.5	1	0.8	20	2	4	6	8	0.2	0.3	1.250
in./100yd.	3.60	1.80	0.13	0.36	0.90	0.36	0.29	7.20	0.72	1.44	2.16	2.88	0.07	0.11	0.45
MOA	3.44	1.72	0.12	0.34	0.86	0.34	0.28	6.88	0.69	1.38	2.06	2.75	0.07	0.10	0.43
<b>3-15x50</b>															
Mils	1.00	0.50	0.05	0.10	0.25	0.12	0.08	2.00	0.20	0.40	0.60	0.80	0.02	0.04	0.125
CM	10	5	0.5	1	2.5	1.25	0.8	20	2	4	6	8	0.2	0.4	1.25
in./100yd.	3.60	1.80	0.18	0.36	0.90	0.45	0.29	7.20	0.72	1.44	2.16	2.88	0.07	0.14	0.45
MOA	3.44	1.72	0.17	0.34	0.86	0.43	0.28	6.88	0.69	1.38	2.06	2.75	0.07	0.14	0.43



## SCR™ MOA Reticle for 2-10X / 3-15X

- MOA-based, proprietary Burris design.
- Increases precision for long-range competition without adding clutter or distraction.
- Extended center illuminated area lets the shooter confidently engage targets at long distances in low light and shadows.
- Increases speed and precision for wind hold-off and for range estimation and impact measurement.

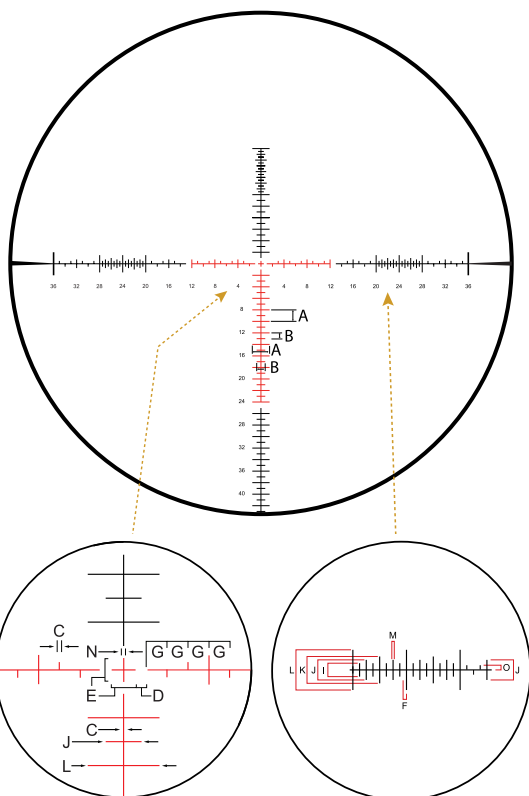

### RETICLE SUBTENSIONS (in MOA)

Model	A	B	C	D	E	F	G	I	J	K	L	M	N	O
2-10x / 3-15x	2	1	0.17	0.5	1	0.5	1	1	1.5	2	3	0.1	0.15	0.5

## SCR™ MOA Reticle for 4-20x / 5-25x

- MOA-based, proprietary Burris design.
- Increases precision for long-range competition without adding clutter or distraction.
- Extended center illuminated area lets the shooter confidently engage targets at long distances in low light and shadows.
- Increases speed and precision for wind hold-off and for range estimation and impact measurement.

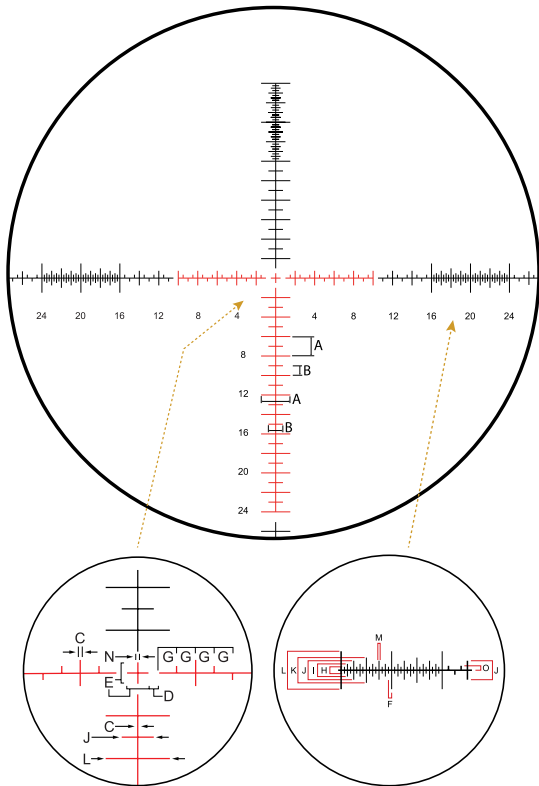

### RETICLE SUBTENSIONS (in MOA)

Model	A	B	C	D	E	F	G	H	I	J	K	L	M	N	O
4-20x / 5-25x	2	1	0.12	0.5	1	0.25	0.5	0.7	1	1.5	2	3	0.07	0.11	0.35

## F-Class MOA Reticle Front Focal Plane Reticle

The F-Class MOA Illuminated Reticle is optimized for long-range F-Class competitive shooting. The reticle is laid out in .5 MOA increments, and includes a secondary horizontal crosshair designed to give the shooter 20 MOA additional adjustment beyond the capability of the turret adjustments while still retaining the ability to use the MOA hash marks for wind hold-off. An illuminated center dot is found at the 0, 10, 20, and 30 MOA marks.

The illumination is not daylight bright and will not always appear red. It is a contrast dot that will appear a lighter color when placed against a dark or black target for easier target acquisition. The illumination is only visible on magnification settings of 32x and above.

**NOTE:** It is only possible to use the 20 MOA grid in lower magnifications when the field of view is large enough to see it; it will disappear from view in higher magnification.

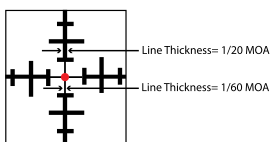
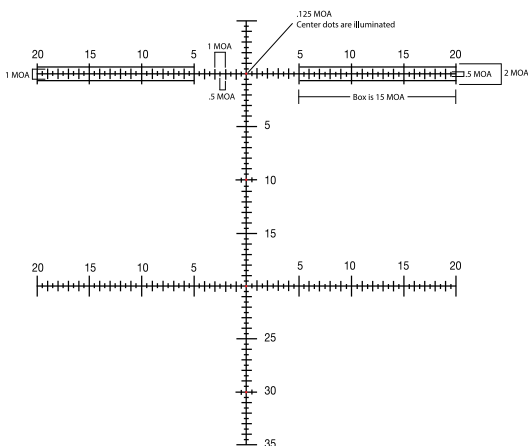

Close-Up of Center Crosshairs at  
0 MOA and 20 MOA

## Warranty

This XTR II line of riflescopes is covered by the  
Burris Forever Warranty™



Thank you for choosing Burris. You can be confident that the optic you purchased is built to the most exacting standards. You can count on Burris to perform every time you use it.

We're so confident in the craftsmanship of our products that we back them with a no questions asked Forever Warranty.

We will repair or replace your Burris optic if it is damaged or defective. The warranty is automatically transferred to future owners.

- No repair or replacement charge
- No warranty card needed
- No receipt needed
- No questions asked



**Burris Company**  
331 East 8th St.  
Greeley, CO 80631  
(970) 356-1670  
BurrisOptics.com  
Facebook.com/BurrisOptics  
INSTR-9000-A