

ZEROTECH

INSTRUCTION MANUAL

ZEROTECH RIFLESCOPES

VENGEANCE

WARNING

KEEP BATTERIES OUT OF REACH OF CHILDREN



**RIFLESCOPES WITH ILLUMINATED
RETICLES CONTAIN BATTERIES**

CONTENTS

PAGES

- | | | | |
|----|-------------------------------------|----|----------------------|
| 4 | INTRODUCTION | 20 | RETICLES |
| 5 | LIFETIME WARRANTY | 22 | SCOPE CARE |
| 6 | SCOPE FEATURES | 23 | WARRANTY INFORMATION |
| 8 | SETTING THE DIOPTRE | 25 | BULLET DROP DETAILS |
| 10 | MOUNTING YOUR SCOPE | | |
| 12 | ADJUSTING PARALLAX | | |
| 14 | ZEROING YOUR RIFLE | | |
| 17 | RESETTING THE TURRETS AFTER ZEROING | | |
| 18 | RETICLE ILLUMINATION FEATURE | | |

INTRODUCTION

WELCOME TO THE ZEROTECH RIFLESCOPE FAMILY!

Customer First - We listened to you and came up with a family of riflescopes that will satisfy the needs of our most discerning and experienced customers.

Backed by Experience - ZeroTech enjoys 55 years of experience in the Optics Market supplying high quality brands to retailers throughout Australia and the Asia Pacific.

Built for the Australian Shooter - Designed and built to endure the harsh conditions of the Australian bush and the exacting demands of the precision shooter.

Lifetime Warranty - Be safe in the knowledge that your scope is backed by our Triple A Lifetime Warranty: **'ANY OWNER, ANY PROBLEM, ALWAYS COVERED'**

Bespoke Reticles - Practical Reticles for the Everyday Shooter.

LIFETIME WARRANTY

BACKED FOR LIFE!

Be safe in the knowledge that your scope is backed by our **Triple A Lifetime Warranty**:

- Fully transferable, covers accidental damage as well as defects in materials and workmanship.
- No receipt or warranty card is required.
- We will repair or replace product with equal or similar value and/or specifications.
- We will return product to you at no charge.



LIFETIME WARRANTY

**'ANY OWNER, ANY PROBLEM,
ALWAYS COVERED'**

SCOPE FEATURES

VENGEANCE 3-12X40 & 4.5-18X40 FEATURES



SCOPE FEATURES

VENGEANCE 4-20X50 (ILLUM. RETICLE) FEATURES



SETTING THE DIOPTRE

BEFORE YOU START USING YOUR SCOPE, IT IS EXTREMELY IMPORTANT TO MAKE SURE YOU HAVE ADJUSTED THE DIOPTRE CORRECTLY. THE CORRECT DIOPTRE SETTING WILL ENSURE THAT YOUR RETICLE REMAINS CLEAR AND SHARP THROUGHOUT THE ENTIRE FOCAL RANGE OF YOUR SCOPE. TO SET YOUR DIOPTRE, FOLLOW THE STEPS BELOW;

1. Set your magnification to the maximum power.
2. If fitted, set the parallax turret to the infinity marker.
3. Find a blank, featureless and bright surface, such as a white wall or clear blue sky and look through your scope for no more than 5 seconds at a time.

NEVER LOOK THROUGH YOUR SCOPE DIRECTLY AT THE SUN.

4. When briefly looking through the scope, the reticle should appear sharp and clear immediately. If the reticle is not immediately sharp and clear, twist the dioptre adjuster to bring the reticle into sharp focus. The dioptre adjuster has approximately $1\frac{3}{4}$ turns of adjustment. We recommend starting with the dioptre assembly twisted flush up against the ocular and making adjustments in an anticlockwise (towards the + symbol marked on the ocular) direction until the optimal setting is reached.
5. Once you have established your dioptre setting, make note of the position of the dioptre for future reference. You will not need to make frequent adjustments to your dioptre unless your setting is disturbed or changed by someone else.



MOUNTING YOUR SCOPE

BEFORE MOUNTING YOUR SCOPE TO A FIREARM, IT IS ESSENTIAL THAT YOU CONFIRM THAT YOUR FIREARM IS UNLOADED AND NO AMMUNITION IS PRESENT IN YOUR WORKSPACE.

TO AVOID DAMAGE AND TO PRESERVE YOUR WARRANTY, YOUR SCOPE SHOULD ALWAYS BE MOUNTED BY AN EXPERIENCED PROFESSIONAL.

1. Once you are satisfied the base(s) is correctly fitted to the receiver of your firearm, proceed to fit the rings to the base(s) and ensure the ring clamps are tightened to the recommended torque settings as specified by the manufacturer.
2. With the ring tops removed, place the scope in the ring bases and gently slide the scope back and fourth in the ring bases to ensure the scope slides freely. If the scope does not slide freely, lapping of the rings may be necessary to avoid damage

to the scope maintube. ZeroTech always recommends the use of high quality rings and bases to ensure the best possible fitting of your scope.

3. Avoid mounting the scope with the rings contacting the junction of the maintube/erector housing, magnification ring/maintube junction or the objective/maintube junction.
4. It is essential to confirm that no part of the scope is contacting the barrel or receiver when the scope is mounted in the rings.
5. Once you have confirmed the fit of the scope in the ring bases, fit the ring tops and tighten the ring top bolts to between 22–25 in lbs or 2.5–2.8NM.
6. ZeroTech highly recommends the use of a scope level (bubble level) fitted to the rings or the scope maintube to ensure the reticle can consistently be aligned with the fall of gravity every time a shot is fired. This is particularly important for precision shooting applications.

***If your level mounts to the maintube of the scope, follow the same guidelines as observed for scope ring fitting to ensure the level does not damage the maintube of your scope.**

ADJUSTING PARALLAX

If your ZeroTech scope is fitted with a parallax turret, it is important to adjust the parallax turret for shots taken at different distances. Some shooters refer to the parallax turret as the 'side focus'. It is referred to as the 'side focus' because by turning the turret, it will bring your target image into focus. As a general rule, and as long as your dioptre is set correctly (refer to page 8 – 'Setting the Dioptre') the sharper the target image is focused, the parallax error will be less.

Parallax error is quite easy to detect when following the instructions below;

1. Acquire your target image at any distance and make sure your rifle is well supported by the use of a bipod and rear bag (or similar).
2. Use the parallax turret to obtain the sharpest/clearest possible target image and establish a refined point of aim on the target.
3. Once you have established a refined point of aim and a sharp target image, move

your head gently up and down whilst looking through the scope. Be sure not to disturb the rifle/ sights.

4. If you observe the reticle departing slightly from the intended point of aim you have parallax error. Make small adjustments on the parallax turret until the reticle remains fixed on your point of aim.
5. You will need to repeat this process when shooting at different distances or in different environmental conditions.
6. **The distance markings on the parallax turret are intended as a guide only.** Dioptre settings and environmental factors are likely to cause the distance markings to vary in relation to the actual distance of the target.



ZEROING YOUR RIFLE

ZEROING DISTANCES

Centrefire Rifles: ZeroTech recommends zeroing most centrefire rifles at approximately 100 metres +/- 10 metres. 100 metres enables the shooter to overcome any offset problems caused by the centre height of the scope above the centre of the bore but is not too far as to accidentally build in an error due to unobserved environmental conditions such as wind. **Rimfire Rifles:** Most commonly, rimfire hunting rifles are zeroed at 50 – 75 metres depending on the type of ammunition being used. Rimfire target rifles may have different zeroing requirements depending on purpose.

We always recommend that you zero your rifle in the same manner as you typically shoot your rifle. For example, if you mainly shoot your rifle from a bench, zero your rifle by shooting from a bench. If you predominately shoot your rifle in the prone position, zero your rifle from the same position.

Before you fire your first shot, you should bore sight your rifle to ensure your scope and your barrel are both aligned at the intended point of impact on your target.

To do this with a bolt action rifle, remove the bolt with the rifle securely supported (front and rear) and align the bore with the target. Without disturbing the rifle, carefully look through the scope and check that the reticle is also aligned with the same point as the bore on the target. If the reticle is not aligned, use the windage and elevation adjustments on your scope to adjust the reticle to the intended point of impact on the target.

Once you are satisfied that the reticle and the bore of your rifle are aligned to the same point on the target, fire a shot at the target and observe the point of impact (bullet hole). If required, use the windage and elevation turrets on your scope to adjust the bullet impact.

Dialling the elevation turret in the direction of the 'U' symbol will adjust the bullet impact upwards on the target. Likewise, dialling the windage turret in the direction of the 'R' symbol will adjust the bullet impact to the right on the target.

- ▲ If your scope turrets are indexed in $\frac{1}{4}$ Minutes of Angle (0.25 MOA), each 'click' of your scope turret will adjust your bullet impact approximately 7-8mm at 100 metres (approx. $\frac{1}{4}$ " at 100 yards).
- ▲ If your scope turrets are indexed in 0.1 Milrad (0.1 MRAD), each 'click' of your scope turret will adjust your bullet impact 1cm at 100 metres (0.36" at 100 yards).

RESETTING THE TURRETS AFTER ZEROING

Once you have obtained a zero on your rifle/ scope, you can remove the windage and elevation turrets using a 3mm Allen key.

1. With the elevation turret in the locked position, loosen the 3mm Allen key keeper located in the top of the turret and set aside.
2. Slide the elevation turret completely away from the scope body and reposition, ensuring that the '0' index mark on the turret lines up with the vertical index mark on the main tube.
3. Refit and tighten the 3mm Allen key keeper and double check the turret is in the '0' position.
4. Repeat this process for the windage turret.

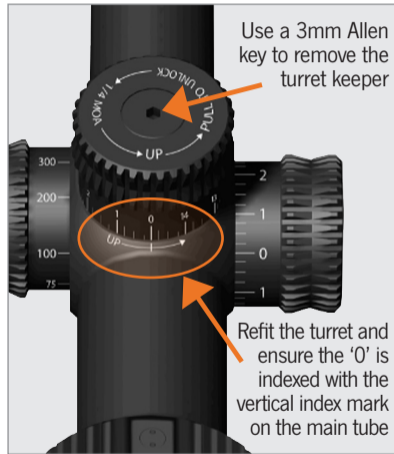

RETICLE ILLUMINATION FEATURE (4-20x50 MODELS)

1. 4-20x50 Vengeance models are available with an optional reticle illumination feature.
2. Before use, you will need to remove the illumination dial battery cap and discard the plastic circuit blocker.
3. The CR 2032 button battery can then be reinstalled and the illumination dial battery cap refitted.
4. The illumination function has 6 different reticle brightness settings as well as an “Off” function between each brightness setting.
5. Be sure to switch your reticle illumination setting to the “Off” position when your rifle is in storage or in transport.
6. We always recommend to carry a spare CR 2032 button battery when you’re using your rifle, especially if you’re heavily reliant on the illumination feature.



REMOVING THE ILLUMINATION BATTERY COVER



WARNING

KEEP BATTERIES OUT OF REACH OF CHILDREN



RIFLESCOPES WITH ILLUMINATED
RETICLES CONTAIN BATTERIES

RETICLES - SECOND FOCAL PLANE

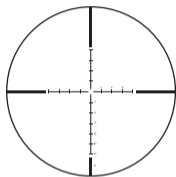

R3 reticle

Available in;
VENGEANCE 4-20x50

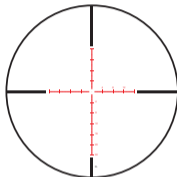

R3 (Illum) reticle

Available in;
VENGEANCE 4-20x50

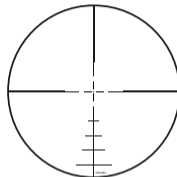

PHR II reticle

Available in;
VENGEANCE 4-20x50

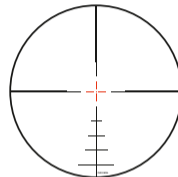

PHR II (Illum) reticle

Available in;
VENGEANCE 4-20x50

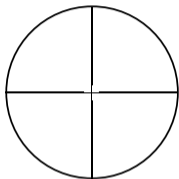

ZEROPLEX reticle

Available in;
VENGEANCE 3-12x40

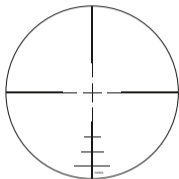

PHR reticle

Available in;
VENGEANCE 4.5-18x40

For specific information on your reticle,
refer to the reticle spec sheet provided
in your scope box or visit
www.zerotech.com.au

SCOPE CARE

1. Wipe dust and debris from your scope body using a damp microfibre cleaning cloth.
2. If necessary, clean dust and dirt from the scope lenses using a lens brush and the ZeroTech lens cleaning cloth.
3. Never spray cleaners or solvents on any part of your scope. Irreversible damage may be caused by such products.
4. Avoid touching the scope lenses. Wipe fingerprints off the scope lenses using the ZeroTech lens cleaning cloth.

WARRANTY INFORMATION

Please direct all enquiries to service@zerotech.com.au

Company details;

ZEROTECH INTERNATIONAL PTY LTD

Ph: +612 9938 3244

Email: sales@zerotech.com.au

Address:

PO BOX 7200,
Warringah Mall
NSW, 2100
AUSTRALIA

VENGEANCE 4-20X50



BULLET DROP DETAILS

CARTRIDGE: _____ PROJECTILE: _____ BC*: _____ VELOCITY: _____

H.O.B.**: _____ TWIST RATE: _____ ZERO DISTANCE: _____

| | DIST. | ELEVATION | DIST. | ELEVATION | DIST. | ELEVATION |
|----------|-------|-----------|-------|-----------|-------|-----------|
| DISTANCE | 100m | | 325m | | 500m | |
| | 150m | | 350m | | 525m | |
| | 200m | | 375m | | 550m | |
| | 225m | | 400m | | 575m | |
| | 250m | | 425m | | 600m | |
| | 275m | | 450m | | 625m | |
| | 300m | | 475m | | 650m | |

* BC = BALLISTIC COEFFICIENT ** H.O.B. = HEIGHT OVER BORE

NOTES



www.zerotech.com.au





LIFETIME WARRANTY

'ANY OWNER, ANY PROBLEM, ALWAYS COVERED'

www.zerotech.com.au



ZERO-TECH 2019 | Printed in China | Specifications subject to change without notice